

# MT-34A

## DIGITAL ATTENUATOR

Programmable Digital  
Attenuator  
200 to 3000 MHz



### OVERVIEW

The MT-34A programmable digital attenuator is a completely shielded, high performance, digitally controlled, 4-channel RF attenuator system. It is intended for any automated RF testing where high accuracy signal power control is needed. The MT-34A offers very good attenuation accuracy, high dynamic range and speed. The high performance of the attenuator is obtained through a high precision attenuator design and calibration.

### Key Features/Benefits

- Frequency range: 200MHz to 3000MHz
- Number of individual channels: 4
- Dynamic Range: 95 dB
- Step: 0.25 dB
- Insertion loss: 4.5dB at 3 GHz
- 0.1 dB compression: 34 dBm
- IP3: 58 dBm
- PoE Powered and Ethernet or USB Interface
- Programmable via Browser or APIs
- Completely shielded and very good accuracy
- Supports Windows, Linux and Mac OS

### Applications

- Wi-Fi up to 802.11be and cellular technologies (GSM, UGPS, LTE-FDD, LTE-TDD, 5G-FR1) testing
- Throughput vs Range measurements
- Wi-Fi or Cellular Roaming measurements
- Mesh, Band-steering
- Receiver Sensitivity Measurements
- System design or device verification testbeds
- Engineering Development and Automated Manufacturing Test

## SPECIFICATION

Parameter		Min	Typ	Max
Frequency Range (MHz)		200		3000
Impedance ( $\Omega$ )			50	
Channels			4	
Attenuation Range (dB)		95		
Shielding (dB)			110	
Isolation between Channels (dB)			90	
Step Size (dB)		0.25		
Insertion Loss (dB)	< 3 GHz		4.5	6.5
Attenuation Accuracy (dB)			$\pm 0.25$	$\pm 1.5$
Switching Speed ( $\mu$ s)			2	
Maximum Input Level (dBm)			+28 (operating) +33 (absolute max)	
Input IP3 (dBm)			58	
Operating modes	Uni/Bi-Directional GUI control or APIs			
Power	Power over Ethernet (PoE)			
Operating Temperature	-30 °C to +70 °C			
RF connectors	SMA			
Control Interface	Ethernet or USB			
Operating System	Windows, Linux and Mac			
Custom APIs as per user requirements	Yes			

## CONNECTIONS

Port Name	Connector Type
RF in	SMA female
RF out	SMA female
USB	USB type Mini-c female
Network (Ethernet/LAN)	RJ45 socket

**Mechanical Outline:**

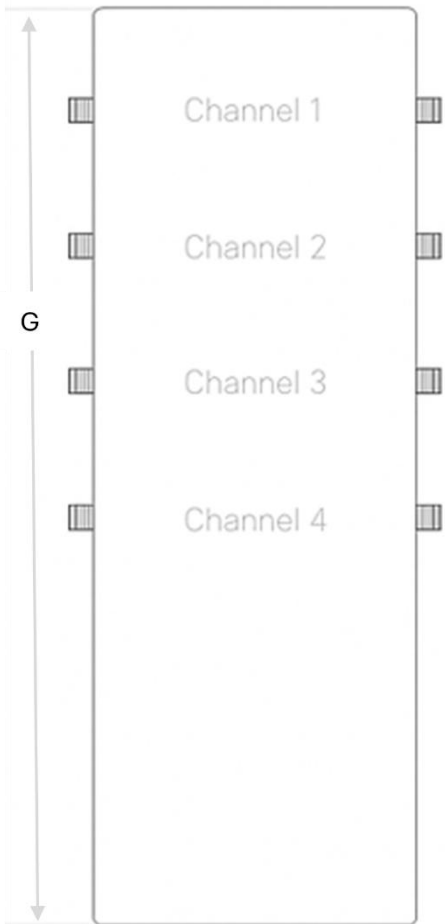
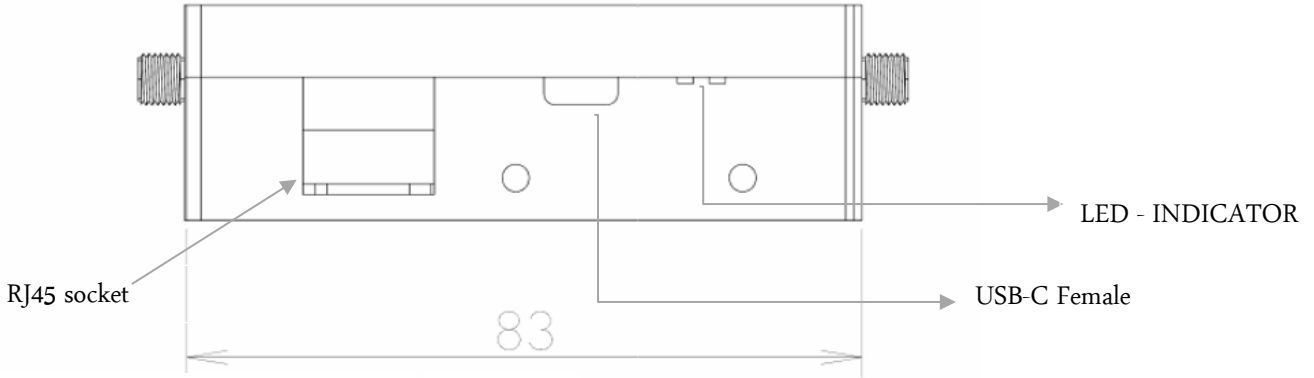

**Isometric View (3D)**

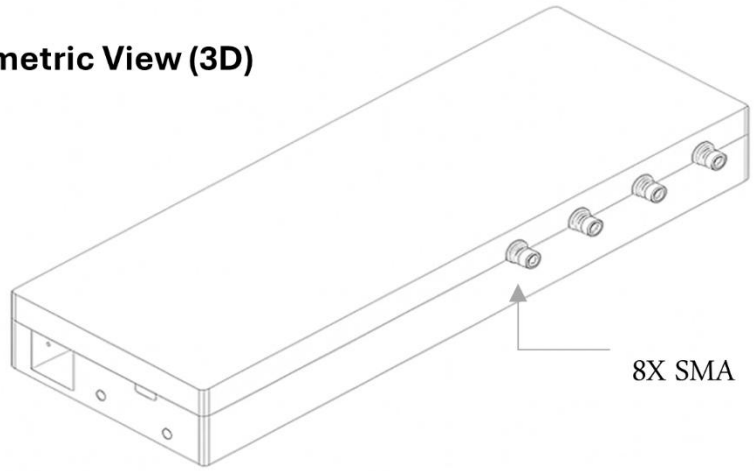

**Right-Side Elevation**

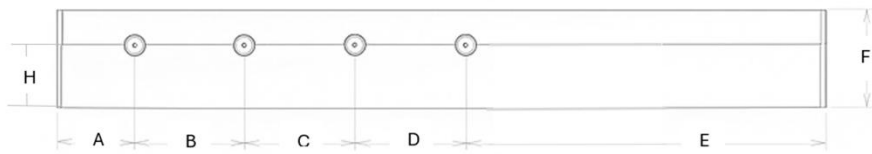

Note: All dimensions are in millimeters (mm). Tolerance  $\pm 0.5$  mm

**Outline Dimension (mm & inch)**

A	B	C	D	E	F	G	H
18	23	22	23	73	26	159	17
0.708	0.906	0.866	0.906	2.874	1.024	6.26	0.591

**PERFORMANCE CURVES**

Frequency vs Insertion Loss

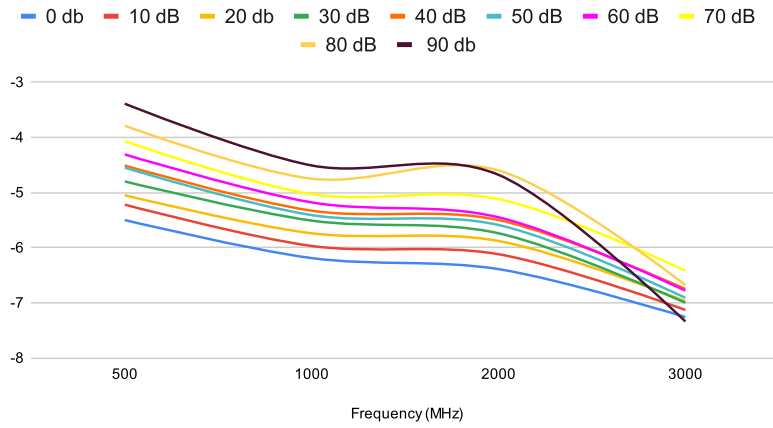

OUTPUT VSWR

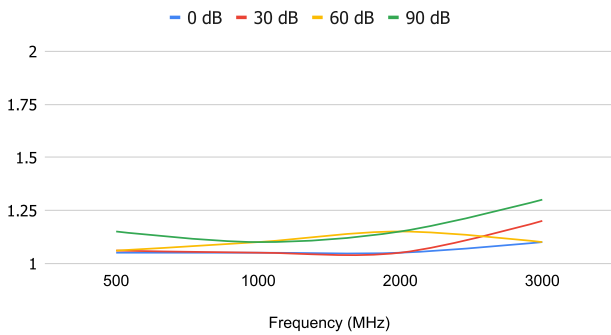

INPUT VSWR

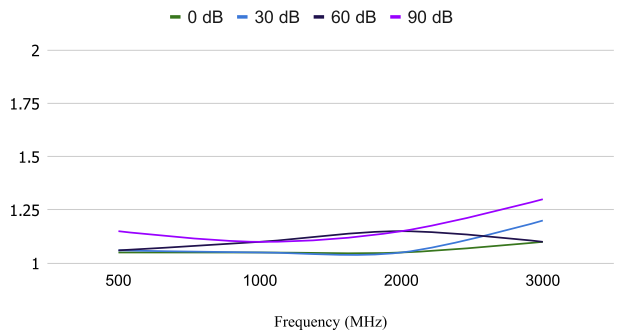

Attenuation accuracy vs frequency

