

MT-64A

DIGITAL ATTENUATOR

Programmable Digital
Attenuator
200 to 6000 MHz



OVERVIEW

The MT-64A programmable digital attenuator is a completely shielded, high performance, digitally controlled, 4-channel RF attenuator system. It is intended for any automated RF testing where high accuracy signal power control is needed. The MT-64A offers very good attenuation accuracy, high dynamic range and speed. The high performance of the attenuator is obtained through a high precision attenuator design and calibration.

Applications

- Wi-Fi up to 802.11be and cellular technologies (GSM, UGPS, LTE-FDD, LTE-TDD, 5G-FR1) testing
- Throughput vs Range measurements
- Wi-Fi or Cellular Roaming measurements
- Mesh, Band-steering
- Receiver Sensitivity Measurements
- System design or device verification testbeds
- Engineering Development and Automated Manufacturing Test

Key Features/Benefits

- Frequency range: 200MHz to 6000MHz
- Number of individual channels: 4
- Dynamic Range: 95 dB
- Step: 0.25 dB
- Insertion loss: 4.5dB at 2.4 GHz & 6dB at 6 GHz
- 0.1 dB compression: 34 dBm
- IP3: 58 dBm
- PoE Powered and Ethernet or USB Interface
- Programmable via Browser or APIs
- Completely shielded and very good accuracy
- Supports Windows, Linux and Mac OS

SPECIFICATION

Parameter		Min	Typ	Max
Frequency Range (MHz)		200		6000
Impedance (Ω)			50	
Channels			4	
Attenuation Range (dB)		95		
Shielding (dB)			110	
Isolation between Channels (dB)			90	
Step Size (dB)		0.25		
Insertion Loss (dB)	< 2.5 GHz		4.5	6
	< 6 GHz		6	7
Attenuation Accuracy (dB)			± 0.25	± 1.5
Switching Speed (μ s)			2	
Maximum Input Level (dBm)			+28 (operating) +33 (absolute max)	
Input IP3 (dBm)			58	
Operating modes	Uni/Bi-Directional GUI control or APIs			
Power	Power over Ethernet (PoE)			
Operating Temperature	-30 °C to +70 °C			
RF connectors	SMA			
Control Interface	Ethernet or USB			
Operating System	Windows, Linux and Mac			
Custom APIs as per user requirements	Yes			

CONNECTIONS

Port Name	Connector Type
RF in	SMA female
RF out	SMA female
USB	USB type Mini-c female
Network (Ethernet/LAN)	RJ45 socket

Mechanical Outline:

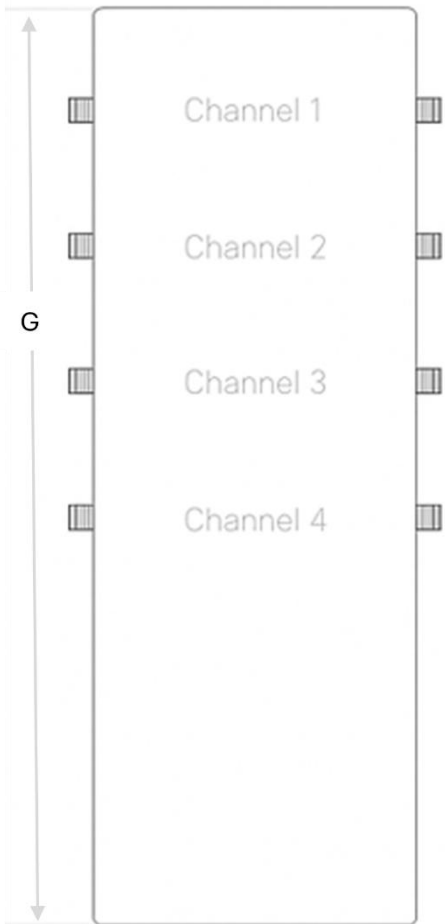
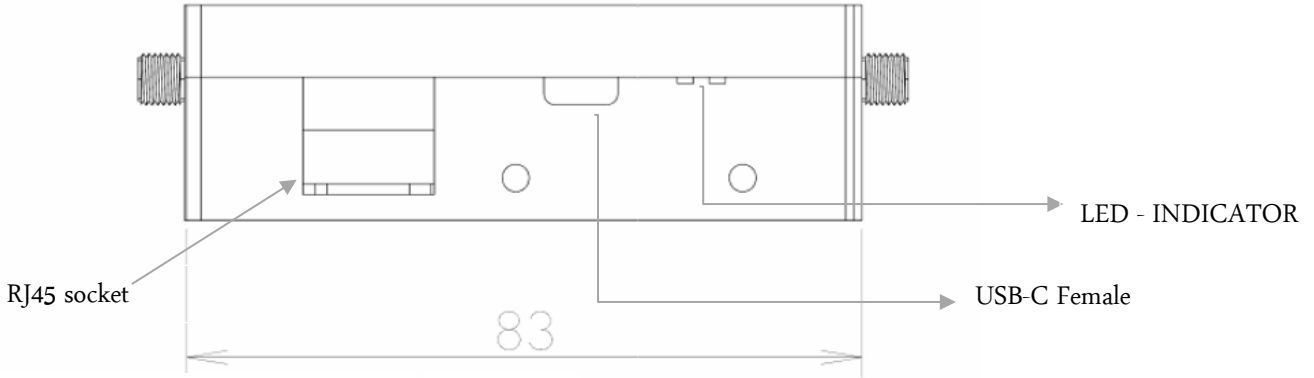

Isometric View (3D)

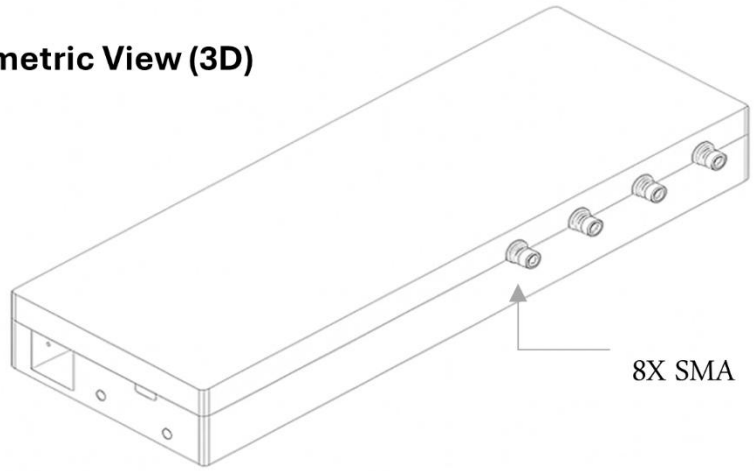

Right-Side Elevation

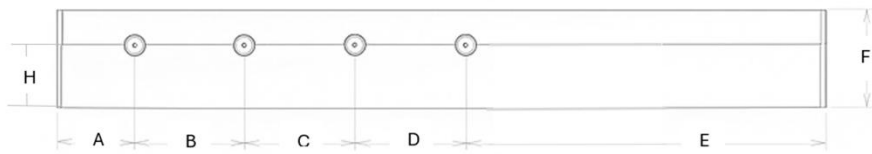

Note: All dimensions are in millimeters (mm). Tolerance ± 0.5 mm

Outline Dimension (mm & inch)

A	B	C	D	E	F	G	H
18	23	22	23	73	26	159	17
0.708	0.906	0.866	0.906	2.874	1.024	6.26	0.591

PERFORMANCE CURVES

Frequency vs Insertion Loss

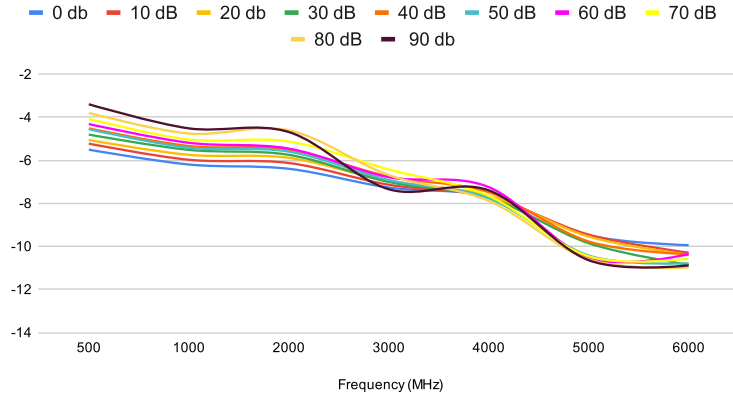

OUTPUT VSWR

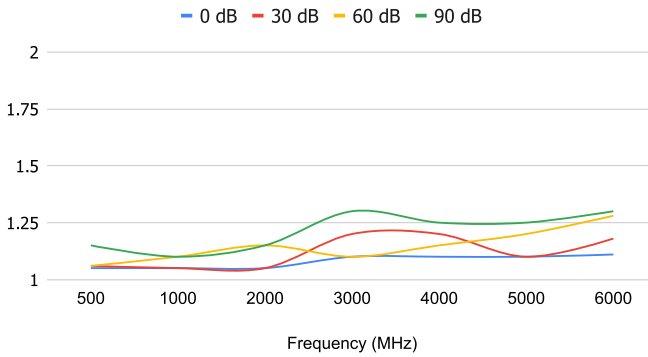

INPUT VSWR

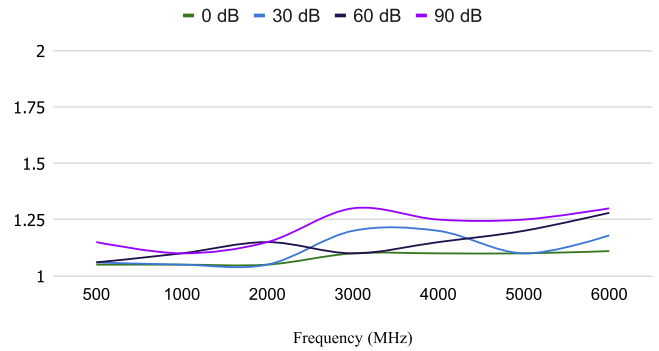

Attenuation accuracy vs frequency

